

COCOON
VOYAGER
QUADCOPTER WITH HD CAMERA
Record your flight in HD



Model Number: IT315007

INSTRUCTION MANUAL



Warranty Note

If you experience any issues with this product, or it's performance is not what you had expected, please contact us at Winplus before returning the item to the store.

It is likely that we can resolve any problems for you via phone or email.

We can be reached on:

Phone: 1300 663 907 (Mon - Fri; 8:30am - 6:00pm EST)

Email: customercare@winplus.com.au

Web: www.winplus.com.au



VOYAGER QUADCOPTER

Warranty Details

The product is guaranteed to be free from defects in workmanship and parts for a period of 12 months from the date of purchase. Defects that occur within this warranty period, under normal use and care, will be repaired, replaced or refunded at our discretion. The benefits conferred by this warranty are in addition to all rights and remedies in respect of the product that the consumer has under the Competition and Consumer Act 2010 and similar state and territory laws.

Our goods come with guarantees that cannot be excluded under the Australian Consumer Law. You are entitled to a replacement or refund for a major failure and for compensation for any other reasonably foreseeable loss or damage. You are also entitled to have the goods repaired or replaced if the goods fail to be of acceptable quality and the failure does not amount to a major failure.

AFTER SALES SUPPORT

 **AUS** 1300 663 907

 customer@winplus.com.au

MODEL: IT315007 PRODUCT CODE: 51176 09/2015



Safety Instructions

Follow all instructions and take notice of all warnings to reduce risk of fire or electric shock.

- Read the instructions in this manual thoroughly before operating your Voyager Quadcopter.
- This Voyager Quadcopter must be operated safely at all times. It is the operator's responsibility to always fly in safe conditions.
- Always check each component of the Voyager Quadcopter is operating correctly before flying.
- Always follow local aviation rules and regulations when flying the Voyager Quadcopter.
- This Voyager Quadcopter is designed for ages 14+.
- Adult supervision is always advisable with any form of flying toy.
- Always ensure your flight area is safe.
- If a problem occurs with the Voyager Quadcopter, always contact the supplier before attempting to fly again.
- Do not fly in windy, rainy or low light conditions.

Winplus Australasia will not take any responsibility for incorrect use of the Voyager Quadcopter.

Rules & Regulations

The following regulations must be followed when operating your Voyager Quadcopter in Australia.

- You must only operate this aircraft in your line-of-sight in daylight.
- You must not fly closer than 30 metres to vehicles, boats, buildings or people.
- You must not fly over populous area, such as beaches, other people's backyards, heavily populated parks, or sports ovals where there is a game in progress.
- If you are in controlled airspace, which covers most Australian cities, you must not fly higher than 120 meters (400 feet).
- You should not fly within 5.5 km of an airfield.
- It's illegal to fly for money or economic reward unless you have an unmanned operator's certificate issued by the Civil Aviation Safety Authority (CASA).

Source: http://www.casa.gov.au/wcmswr/_assets/main/lib100071/flying_with_control_model.pdf

It is the Voyager Quadcopter operator's responsibility to regularly check and obide by the current rules and regulations.

Incorrect operation of this Voyager Quadcopter may result in severe injury, loss of property or fines. Winplus Australasia does not take any responsibility if local rules and regulations are not followed.

After Sales Support

 1300 663 907

 customercare@winplus.com.au

Model Number IT315007

Contents

Warranty Details	4
Safety Instructions	5
Rules & Regulations	5
Parts List	7
Technical Specifications	7
Features	7
Product Overview	8
1.1 Voyager Quadcopter	8
1.2 Remote Control - Buttons	8
1.3 Remote Control - Display	9
Installation	10
2.1 Installing the Control Batteries	10
2.2 Charging and Inserting the Voyager Quadcopter Battery	10
2.3 Installing Landing Skids and Blade Guards	11
2.4 Safe Flight Environment	11
2.5 Pairing the Voyager Quadcopter with the Remote	11
Operation	12
3.1 Flying the Voyager Quadcopter	12
3.2 Fine Tuning	13
3.3 Using the Camera	13
3.4 Speed Control	14
3.5 Tricks	14
3.6 Mid Air Start	14
3.7 Changing to Mode 2	14
3.8 Mode 2: Flying	15
3.9 Mode 2: Fine Tuning	15
3.10 Resetting the Voyager Quadcopter	16
3.11 Replacing Propellor Blades	16
FAQs	17
Repair and Refurbished Goods or Parts Notice	18
Flight Log	19

Parts List

- | | |
|----------------------------------|------------------------------|
| 1 x Voyager Quadcopter | 1 x USB Charging Cable |
| 1 x Remote Control | 4 x ActivEnergy AA Batteries |
| 4 x Replacement Propeller Blades | 1 x Instruction Manual |
| 4 x Blade Guards | 1 x Getting Started Guide |
| 1 x Screwdriver | 1 x Warranty Card |



Technical Specifications

Voyager Quadcopter Input:	3.7V, 500 mAh
Voyager Quadcopter Battery Type:	Lithium-Ion
Charging time:	75 minutes (USB recharge)
Flying time:	7 minutes
Remote range:	50 meters
Frequency:	2.4 GHz (4 channel)
Video Resolution:	720P
Image Resolution:	3.6MP

Features

- Low-voltage protection:** If the Voyager Quadcopter's battery gets too low, the rotors will stop, protecting the battery from damage.
- Over-current protection:** If the Voyager Quadcopter's blades become jammed, the control will stop supplying power to the rotors automatically.
- 3D Eversion:** Built-in functions allow you to perform advanced manoeuvres with ease.
- 6-Axis Gyroscope:** Ensure the Voyager Quadcopter remains steady when flying.

After Sales Support

 1300 663 907

 customercare@winplus.com.au

Model Number IT315007

Product Overview

1.1 Voyager Quadcopter

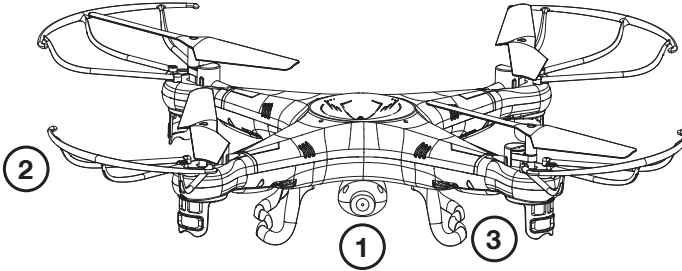

- 1. Camera
- 2. Propeller Guards
- 3. Landing Skids

1.2 Remote Control - Buttons

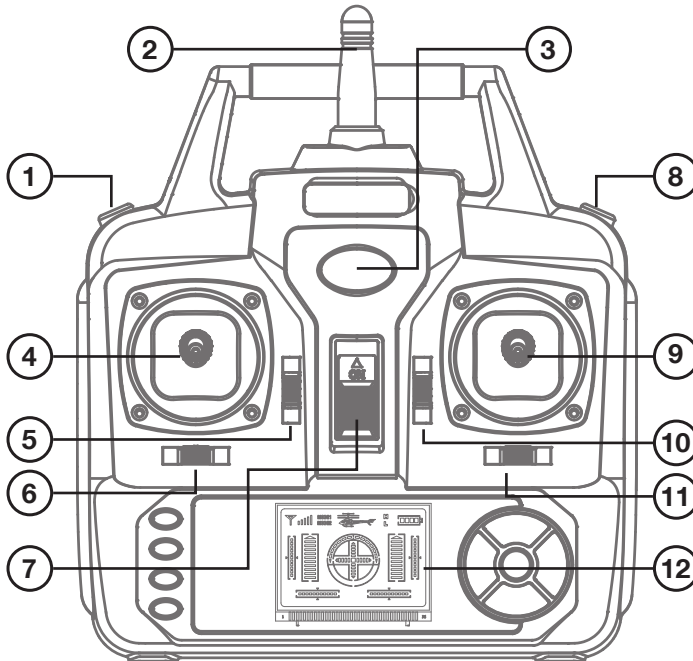

- 1. High/Low Speed Button
- 5. Photo/Video Switch
- 9. Right Control Stick
- 2. Antenna
- 6. Left Tuning Switch
- 10. Forward/Back Trim
- 3. Indicator
- 7. On/Off Switch
- 11. Mode Switch
- 4. Left Control Stick
- 8. Trick Button
- 12. LCD Display

After Sales Support

1300 663 907

customercare@winplus.com.au

Model Number IT315007

Product Overview

1.3 Remote Control - Display

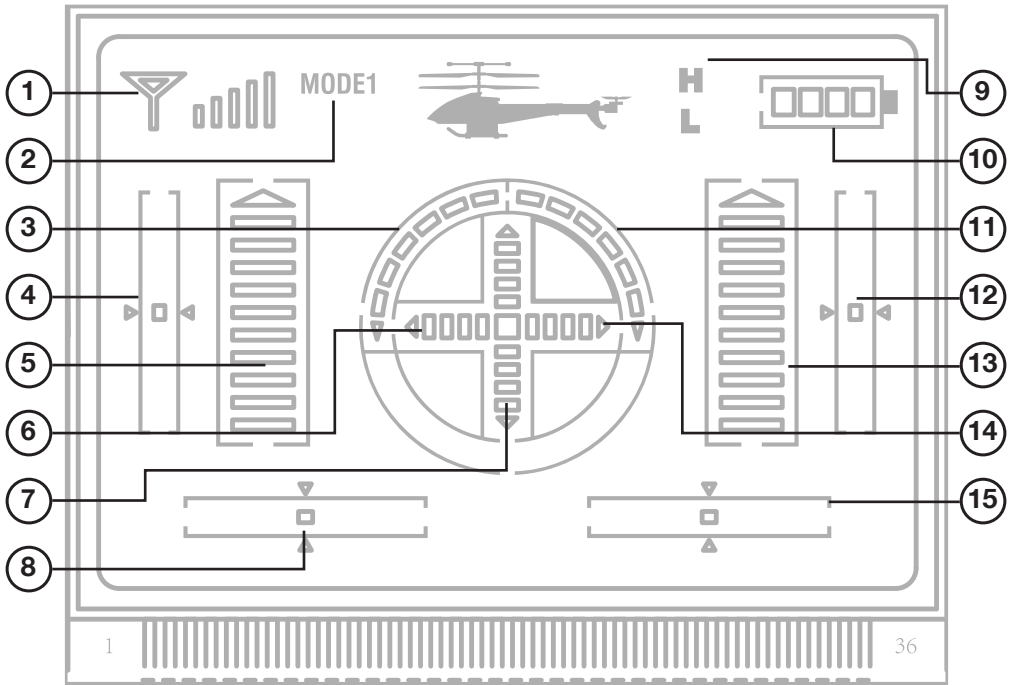

- | | | |
|-------------------------------|--------------------------------|----------------------------------|
| 1. Signal Indicator | 7. Backward | 12. Forward/Backward Fine-tuning |
| 2. Mode Indicator | 8. Turn Left/Right Fine-tuning | 13. Throttle |
| 3. Turn Left | 9. High/Low Speed Indicator | 14. Left |
| 4. Throttle Lever Fine-tuning | 10. Control Battery Level | 15. Sideways Fine-tuning |
| 5. Throttle | 11. Turn Right | |

After Sales Support

1300 663 907

customercare@winplus.com.au

Model Number IT315007

Installation

2.1 Installing the Control Batteries

1. Use a screwdriver to remove the screw on the back of the remote control, then open the battery cover.
2. Install 4x AA batteries into the back of the remote control. Please note the polarity positions indicated.
3. Replace the cover and reinstall the screw.

Note: For best performance, do not mix different types of batteries.

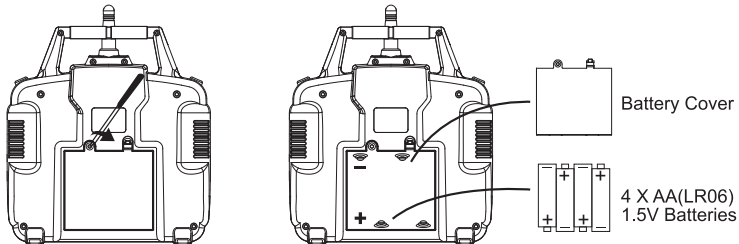

2.2 Charging and Inserting the Voyager Quadcopter Battery

1. Push the on/off switch of the Voyager Quadcopter to off, then open the battery cover.
2. Pull out the battery wire from the power port and remove battery.
3. Insert the battery power port into the small end of the USB charging cable.
4. Insert the other end of the USB charging cable into a USB port. The charging indicator will now turn on.
5. Once the charging indicator has turned off, the battery is fully charged. A full charge will take approx. 75 minutes.
6. Disconnect the USB cable from the USB port.
7. Disconnect the battery power port from the small end of the USB charging cable.
8. Reconnect the battery wire to the power port on the Voyager Quadcopter.
9. Close the battery cover. To ensure it is securely closed, push cover in until it snap-locks into place

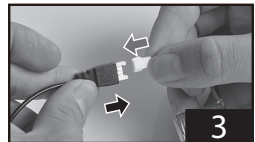
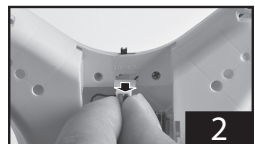
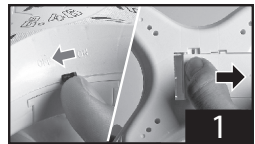

*Note: Always charge in a dry and ventilated area.
Always remove the battery from the quadcopter when charging.
Do not charge the battery if the surface is still warm.
Only use the original USB charging cable provided.
Replace the battery if it becomes swollen.*

After Sales Support

1300 663 907

customercare@winplus.com.au

Model Number IT315007

Installation

2.3 Installing Landing Skids and Blade Guards

1. Insert the blade guards onto each of the wings as shown (fig 2.3.1).
2. Secure the blade guards with screws.

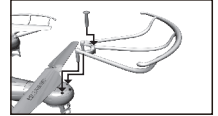

fig 2.3.1

2.4 Safe Flight Environment

Always check that you are following the rules and regulations for your location.

2.5 Pairing the Voyager Quadcopter with the Remote

1. Push the ON/OFF switch on the remote control to ON.
2. Open the Voyager Quadcopter battery cover and insert the battery connector to the power port.
3. Close the battery cover and turn on the Voyager Quadcopter. The Voyager Quadcopter LED's will commence flashing to indicate that it is attempting to pair to the control.
4. Ensure the Voyager Quadcopter is placed on a level surface.
5. Push the left control stick to the highest position until you hear the remote control beep, then pull down to the lowest position until you hear another beep. When successfully paired, the lights on the quadcopter will stop flashing and change to solid colours.

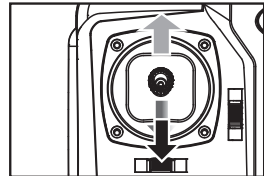
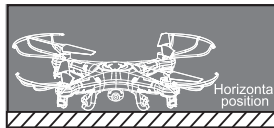

Operation

3.1 Flying the Voyager Quadcopter

NOTE: The best way to know which direction the Voyager Quadcopter is facing is by the coloured LEDs on its wings. The red lights are on the front two wings, the green lights are on the back wings. Always keep the Quadcopter in direct line of sight.

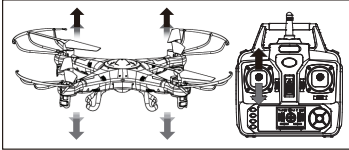

Hover up and down:

Push the left control stick up or down. The Voyager Quadcopter will fly upward or downward.

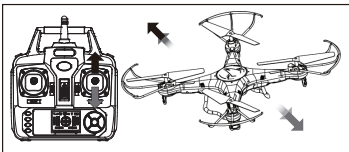

Forward and backward:

Push the right control stick up or down. The Voyager Quadcopter will fly forward or backward.

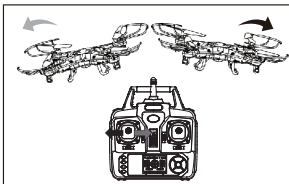

Turn Left and Right:

Pull the left control stick left or right. The Voyager Quadcopter will turn left or right.

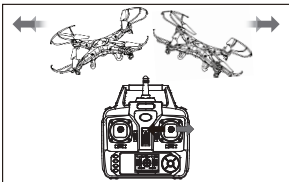

Sideward fly:

Pull the right control stick left or right. The Voyager Quadcopter will fly left or right.

Operation

3.2 Fine Tuning

The Voyager Quadcopter should keep steady when using the left control stick only. At times however, you may need to fine tune the control to keep the Voyager Quadcopter steady. Depending on the issue, use the following buttons to fine tune the Voyager Quadcopter;

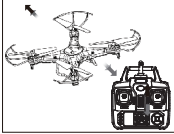

Flying forward/backwards:

Use the forward/back switch.

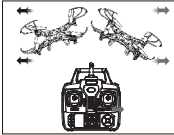

Flying left/right:

Use the mode switch.



Rotating left/right:

Use the left tuning switch.

Note: The amount of fine tuning is indicated on the remote control LCD display.

3.3 Using the Camera

1. Ensure a Micro SD card is securely inserted into the camera.

Note: The gold contacts should be facing down

2. Ensure the camera is connected to the Voyager Quadcopter correctly, and that the green light indicator is on prior to flying.

3. Taking a Photo:

- a. Press the Photo/Video switch on the remote control upwards to take a photo. The camera LED will flash red to indicate that a photo has been taken.

4. Taking a Video:

- a. Press the Photo/Video switch on the remote control downwards to start taking a video. The camera LED will change to RED to indicate a video is being recorded.
- b. Press the Photo/Video switch on the remote control downwards again to stop taking a video. The Camera LED will change back to GREEN.



Operation

3.4 Speed Control

This Voyager Quadcopter can be operated at low speed and high speed settings. These are indicated by the 'L' and 'H' on the top right corner of the LCD display.

To change between low and high speed, press the 'High/Low speed button' on the top left corner of the remote control.

3.5 Tricks

Once you are familiar with basic flight operations, you can perform some impressive tricks.

1. Fly the Voyager Quadcopter to a height of more than 3 metres.
2. Hold down the Trick button on the top right side of the remote control.
3. While still holding down the Trick button, push the right control stick in any direction to perform a 360 degree flip.

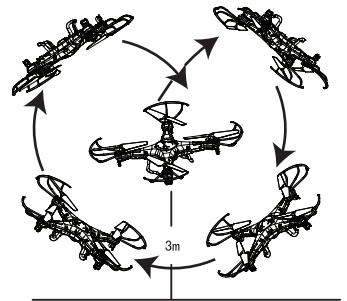

3.6 Mid Air Start

Thanks to the 6-axis gyroscope, you can throw the Voyager Quadcopter and push the throttle upwards. The Voyager Quadcopter will automatically level out and hover smoothly in the sky.

3.7 Changing to Mode 2

This Voyager Quadcopter allows you to swap the sideward control with turn left/right control.

1. With the remote control turned off, hold the Mode Switch to the right.
2. Turn on the remote control. A longer beep sound indicates the mode has been changed. You will also notice that Mode 2 is now shown on the LCD display.

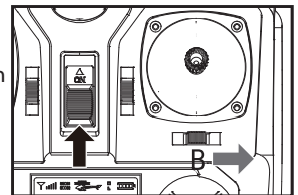

Note: To return to Mode 1, perform these steps again.

Operation

3.8 Mode 2: Flying

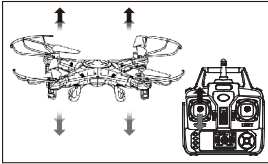

Hover up and down:

Push the left control stick up or down. The Voyager Quadcopter will fly upward or downward.

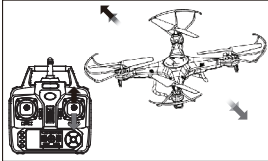

Forward and backward:

Push the right control stick up or down. The Voyager Quadcopter will fly forward or backward.

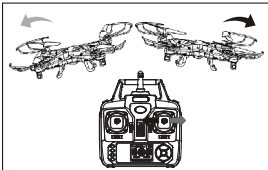

Turn Left and Right:

Pull the right control stick left or right. The Voyager Quadcopter will turn left or right.

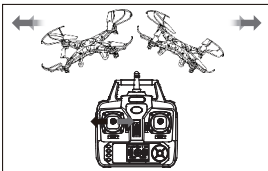

Sideward fly:

Pull the left control stick left or right. The Voyager Quadcopter will fly left or right.

3.9 Mode 2: Fine Tuning

Depending on the issue, use the following buttons to fine tune the Voyager Quadcopter;

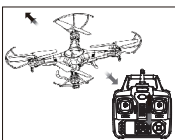

Flying forward/backwards:

Use the forward/backward switch.

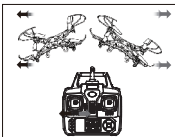

Flying left/right:

Use the left tuning switch.

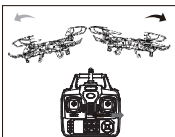

Rotating left/right:

Use the mode switch.

After Sales Support

 1300 663 907

 customercare@winplus.com.au

Model Number IT315007

Operation

3.10 Resetting the Voyager Quadcopter

In the event of the Voyager Quadcopter flying in a strange manner, first check that there is no issue with fine tuning on the remote control.

If fine tuning did not solve the issue, you can reset the Voyager Quadcopter to factory settings with this method:

1. Perform the steps in “Pairing the Quadcopter with the Remote Control” to pair with the Voyager Quadcopter.
2. Hold both control levers at their bottom right position. The Voyager Quadcopter LED’s will flash rapidly.
3. After 2-3 seconds, the LEDs will stop flashing and change to a solid colour. This indicates that the Voyager Quadcopter has restarted and reset successfully.

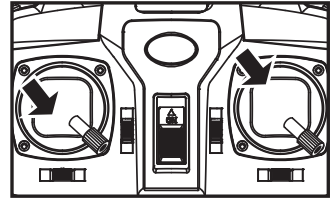

3.11 Replacing Propellor Blades

Eventually your propeller blades may need to be replaced. Do not operate the Voyager Quadcopter with damaged propeller blades as you may suddenly lose control of the Quadcopter during flight. Follow the steps below to replace your Voyager Quadcopter’s propeller blades.

1. Position the Voyager Quadcopter on a level, horizontal surface with the front end facing forward, as shown below.
2. Determine which blades need replacing and note the blade type (A or B) by checking the underside of the blade.
3. Using the screwdriver provided, unscrew the damaged blade.
4. Replace the blade with the same type (A or B), also checking the diagram below to confirm the correct blade type.
5. Screw in the replacement blade firmly using the screw that was removed in step 3.
6. When flying your Voyager Quadcopter again, gently increase the throttle to check that the Voyager Quadcopter will remain stable when flying. If the incorrect blade type is used, the Voyager Quadcopter will be unable to remain level.

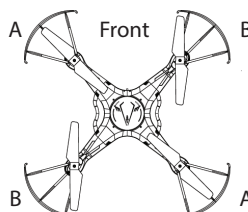

FAQs

Question	Solution
My Voyager Quadcopter didn't pair with my Remote Control	At times the Voyager Quadcopter may fail to pair with the remote control. Attempt to pair again, ensuring the Voyager Quadcopter is resting on a level surface.
My Voyager Quadcopter isn't responding	Check that the battery in the Voyager Quadcopter is still charged. Also check that the remote control batteries are still charged.
My Voyager Quadcopter is slow to respond	Ensure that the remote control batteries are still charged. There may also be interference from a similar frequency nearby. Try using the Voyager Quadcopter in a different location, away from other radio controlled devices.
Not flying straight or spinning	Follow the steps in 'Fine Tuning' to configure the Voyager Quadcopter correctly. If unsuccessful, also try following the steps in 'Resetting the Voyager Quadcopter'.
My video wasn't saved	To save power, the Voyager Quadcopter only saves videos when you press the video button to stop recording. Unfortunately, if the Quadcopter runs out of power whilst recording, the video won't be saved. Recharge the Voyager Quadcopter and try taking a video again, making note of how much battery may be remaining.



VOYAGER QUADCOPTER

Repair and Refurbished Goods or Parts Notice

Unfortunately, from time to time, faulty products are manufactured which need to be returned to the Supplier for repair.

Please be aware that if your product is capable of retaining user-generated data (such as files stored on a computer hard drive, telephone numbers stored on a mobile telephone, songs stored on a portable media player, games saved on a games console or files stored on a USB memory stick) during the process of repair, some or all of your stored data may be lost.

We recommend you save this data elsewhere prior to sending the product for repair.

You should also be aware that rather than repairing goods, we may replace them with refurbished goods of the same type or use refurbished parts in the repair process.

Please be assured though, refurbished parts or replacements are only used where they meet ALDI's stringent quality specifications.

If at any time you feel your repair is being handled unsatisfactorily, you may escalate your complaint. Please telephone us on 1300 663 907 or write to us at:

Winplus Australasia
PO BOX 537
Bayswater Business Centre
Bayswater, VIC 3153

Winplus Help Desk 1300 663 907
(Operating Hours: Mon-Fri 08:30AM to 6:00PM)

customercare@winplus.com.au
www.winplus.com.au

AFTER SALES SUPPORT

 (AUS) 1300 663 907

 customercare@winplus.com.au

MODEL: IT315007 PRODUCT CODE: 51176 09/2015



 cocoon™